

GEZE Delivery Conditions/Packing Regulations Version 3.0

These GEZE Delivery Conditions/Packing Regulations are binding and replace the previous regulations: GEZE Delivery Conditions/Packing Regulations Version 2.6

Contents

1. Basics	2
2. Delivery addresses	2
3. Delivery times.....	3
4. Accompanying document Delivery note.....	3
5. General packing requirements - independent of packing type	3
6. Labelling the packaging.....	4
7. Standard packaging.....	4
7.1. Exchangeable materials	4
7.1.1. Pallets.....	4
7.1.2. Cage pallets	5
7.2. Disposable packaging.....	6
7.2.1. Special pallets / plastic pallets	6
7.2.2. Cartons.....	6
8. Container management	7
8.1. Small load carriers (KLTs)	8
8.2. Bito container.....	9
8.3. Magnum container	9
9. GEZE containers (GEZE property).....	10
10. Barcode usage on the delivery note and the containers	11
11. GEZE packaging for long goods	13
12. Glass deliveries.....	15

1. Basics

The following transportation and packaging regulations are considered part of our General Terms and Conditions, independent of the agreed delivery conditions.

The goods are to be delivered by truck, which can be unloaded via a loading dock. Sprinter vans or similar vehicles are not suitable for deliveries. Deliveries that are made in an unsuitable vehicle must be rejected.

GEZE will assume transport costs if applicable, corresponding to the arranged delivery condition.

We will only accept deviations from GEZE's prescribed packing standard with a written agreement.

We will only recognise higher transportation costs from a change in dispatch costs resulting from this regulation, e.g. air freight, train express, express parcels, courier service etc., if such a dispatch type has been expressly prescribed and approved by us.



Deliveries that are rejected by quality inspection or logistics due to packing that has not been agreed on or complied with are returned to the supplier at his cost.

2. Delivery addresses

Production plant

GEZE GmbH
Reinhold-Vöster-Straße 21-29
D-71229 Leonberg
Production hall 1 (gate 1 and 2)
Production hall 2 (gate 3)

Distribution centre

GEZE GmbH
Breitwiesenstraße 8
D-71229 Leonberg

3. Delivery times

Production plant

Monday - Thursday: 7:00 AM - 3:00 PM
Friday: 7:00 AM - 2:00 PM

Distribution centre

Monday-Friday: 6:00 AM - 10:00 PM

4. Accompanying document Delivery note

A single copy of the delivery note should accompany the goods and must include the following order details:

- Supplier name
- Delivery note number - also as barcode 128 (see Point 12)
- Our order number and its position - also as barcode 128 (see Point 12)
- GEZE identification number
- Quantity for the specific GEZE identity number
- Number of packages as well as the filling quantity per package
- Pipeline order number and small load carrier type and specific quantity (please observe the detailed information on container management under Point 8)

5. General packing requirements - independent of packing type

- Transport securing devices and labelling of fragile goods
- Problem-free unloading with a forklift vehicle
- Stacking capacity
- Observing the prescribed standard measurements
- The goods must not protrude above the container
- Plastic bags must be closed in such a way that the materials cannot fall out of them.

6. Labelling the packaging

- Our order number and its position - also as barcode 128 (see Point 12)
- GEZE identification number
- Product designation
- Filling quantity (number of pcs.)
- Weight
- Delivery note number - also as barcode 128 (see Point 12)

7. Standard packaging

The packaging type, size and fill quantity are indicated in the order for all materials. The specific operational purchaser is available for any questions.

In the following section, you will find the packaging that is used at GEZE:

7.1. Exchangeable materials

Exchangeable materials (Euro pallets and cage pallets) can generally be exchanged directly at goods delivery.

If the required quantity is not available, exchangeable materials can be picked up following coordination during production factory delivery hours.

Contact: Incoming goods GEZE GmbH
wareneingang.de@geze.com

7.1.1. Pallets

Only pallets that meet the regulations of the European Pallet Association (EPAL), the World Pallets and plastic pallets with dimensions of 1200 x 800 mm are accepted.

The height of a shipment delivered on euro pallets must not exceed 75 cm including the pallet.

A euro container cover plate can be used for stabilising and stacking several pallets. This distributes the weight of the pallets above it evenly between the goods.

Strapping of the load incl. the euro container cover plate is recommended for additional securing of the load.



7.1.2. Cage pallets

Cage pallets must meet the quality requirements of the European Pallet Association (EPAL).
The dimensions are 1230 x 830 x 970 mm.



7.2. Disposable packaging

7.2.1. Special pallets / plastic pallets

If delivery as described in Point 7 is not possible and special and/or plastic pallets with different dimensions must be used, this must be coordinated with the specific operational purchaser. If there is no coordination, this may result in acceptance being denied.

7.2.2. Cartons

If cartons have been agreed as the packing material, the following GEZE standards apply:

- Weight limit: max. 15 kg per carton
- Sorted packing
- Fill material: only carton and cardboard materials
- The defined carton size must not be changed without consultation
- The agreed carton dimensions must not be exceeded; somewhat smaller is possible
- The dimensions of the GEZE cardboard packaging requirements are oriented towards the dimensions of small load carriers (see chart):

		Dimensions (mm)	
GEZE carton designation	GEZE KLT designation	KLT designation	Outside
A1	K1	KLT 3215	30x200x147
A2	K2	KLT 4329	400x300x280
A3	K3	KLT 6429	600x400x280
A4	K4	KLT 4315	400x300x147
A5	K5	KLT 6415	600x400x147

8. Container management

In order to ensure a sufficient and prompt supply of containers KLT 3215, KLT 4329, KLT 6429, KLT 4315, KLT 6415, FCL containers, Bito containers and lid 1208, GEZE introduced a new container management process on 01/11/2011.

This is a so-called sale/buy-back system and works as follows:

Please see your order for the container regulations for GEZE materials. Request the needed containers directly from our service provider.

You can obtain all the information you need from our Procurement Department. Please refer to your order for details of the person to contact for this purpose.

You will receive access to our service provider's portal for ordering your containers.

Please note the minimum purchase quantities (container quantities/quantities per pallet). Smaller amounts are not permitted.

You will receive an invoice from our service provider for the containers that you have ordered.

When you make the delivery of goods to GEZE, you sell the containers to GEZE on the same terms.

Please note that for every delivery to GEZE you should specify on your delivery note your pipeline order number and the respective euro container incl. the number of pieces., so that the euro containers that are supplied can be logged by GEZE.

Please also create a specific item for the euro containers on your goods invoice and quote the pipeline order number for this purpose.

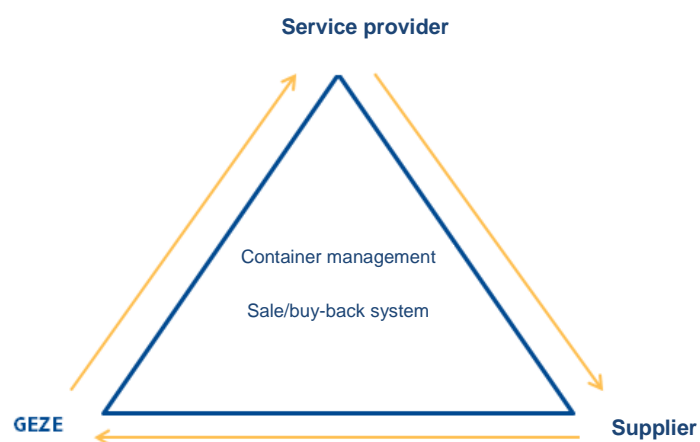

8.1. Small load carriers (KLTs)

The following small load carriers are used at GEZE:

Designation	GEZE designation	Figure	Dimensions (mm)	
			Inside	Outside
KLT 3215	K1	Fig. 1	243x162x129.5	300x200x147
KLT 4329	K2	Fig. 2	346x265x242	400x300x280
KLT 4315	K4	Fig. 4	346x265x109.5	400x300x147
KLT 6429	K3	Fig. 3	544x364x242	600x400x280
KLT 6415	K5	Fig. 5	544x364x109.5	600x400x147
KLT A1208	Lid	Fig. 6	1200x800x94	

- Weight limit: max. 15 kg per small load carrier



Fig. 1



Fig. 2



Fig. 3



Fig. 4



Fig. 5



Fig. 6

8.2. Bito container

		Dimensions (mm)		
Designation	GEZE designation	Figure	Inside	Outside
Bito XL	XL container	Fig. 7	762x562x301	800x600x420



Fig. 7

8.3. Magnum container

Only Magnum containers with the dimensions mentioned below are accepted.

		Dimensions (mm)		
Designation	GEZE designation	Figure	Inside	Outside
FLC+lid	Magnum container	Fig. 8+9	1120x720x767	



Fig. 8



Fig. 9



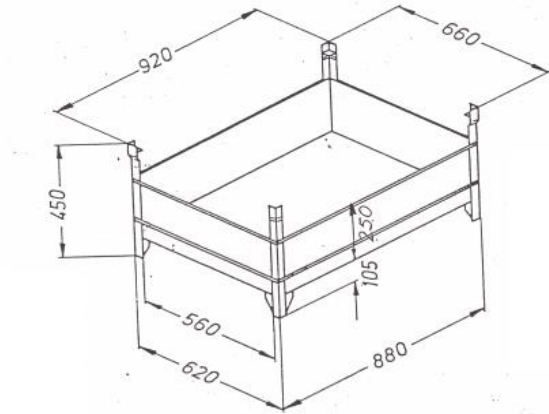

9. GEZE containers (GEZE property)

These are reusable steel containers from GEZE. The attachment of labels, tape etc. to the container is prohibited.



If GEZE containers have been stipulated as the delivery packaging, you can request these in our distribution logistics area at the e-mail address: sth-log.de@geze.com by providing the GEZE order number.

Example of delivery note:

Sample delivery note		
<p>Sender Company example Sample street 1 12345 Sample city</p> <p>Recipient GEZE GmbH</p> <p>Reinhold-Vöster-Straße 21-29 71229 Leonberg</p>	<p>PURCHASE ORDER Date: 01.122014 Contact person Mr. Smith Delivery note no.: 123456789</p> <div style="text-align: center;">  123456789 </div>	
	Delivered	Ordered
80345678 Pos. 10		
Sample part A ID 001234	10 pcs.	10 pcs.
		 00803456780010
80345678 Pos.20		
Sample part B ID 005678	5 pcs.	10 pcs.
45000000		 00803456780020
KLT3215	10 pcs.	
KLT6429	5 pcs.	 45000000

Please note the barcode format of the order numbers given in the example.

e.g.: Order number: 80345678

Barcode: **00803456780010**

Order no. Pos.

11. GEZE packaging for long goods

Materials with a length exceeding 3.5 m are considered long goods.

Small quantities (max. 10 pcs.) can be delivered in small bundles.

A wooden board (wooden slat) is needed as an underlay.

Large quantities (min. 10 pcs.) must be delivered in large bundles.

Max. exterior dimensions of the delivery of 450 x 450 mm must be observed for both types of packaging.

(Width x height; incl. wooden frame; excl. **square timber/vertical wooden members**).

The following regulations apply for the delivery of large bundles:

Labelling on both end faces:

- GEZE identification number
- Product designation
- Filling quantity (number of pcs.)
- Gross weight (max. 1 t: higher weights after consultation)



Please note that only wood with the IPPC standard can be used.

Required packing materials:

- Cardboard all around and on the ends (corrugated paper does not provide sufficient protection)
- Corner protection and/or wooden slats on both the top and bottom corners
- Paper insert to protect the profile
- Square timber / vertical members (at least 90 mm high)
- Plastic or steel strapping band

This packing regulation applies to all long material deliveries (> 3.50 metres), unless a more detailed and/or differing packaging has been arranged. In such cases the packing regulation jointly agreed applies, which is always indicated on the GEZE orders.

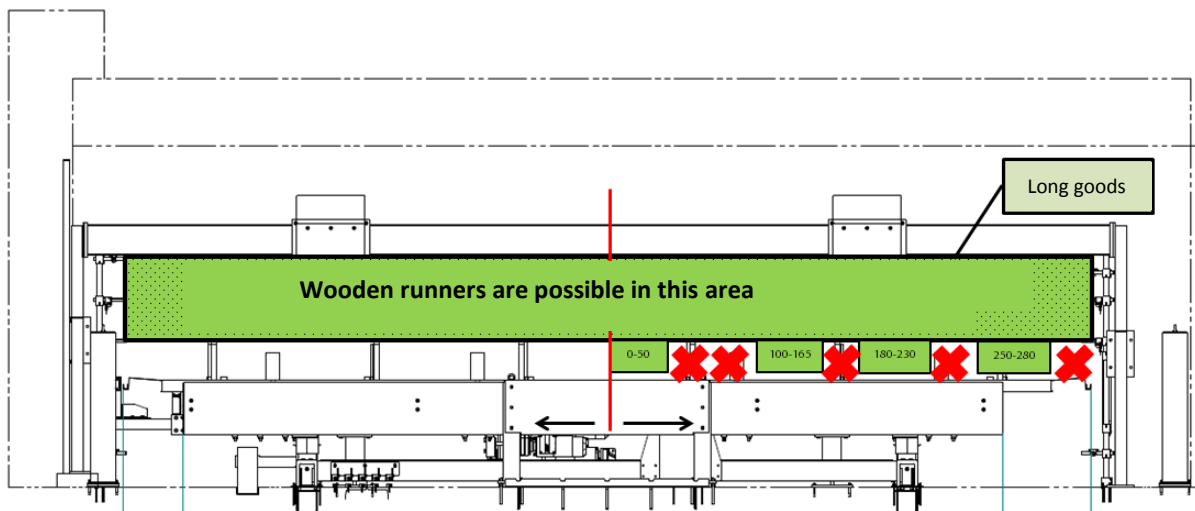
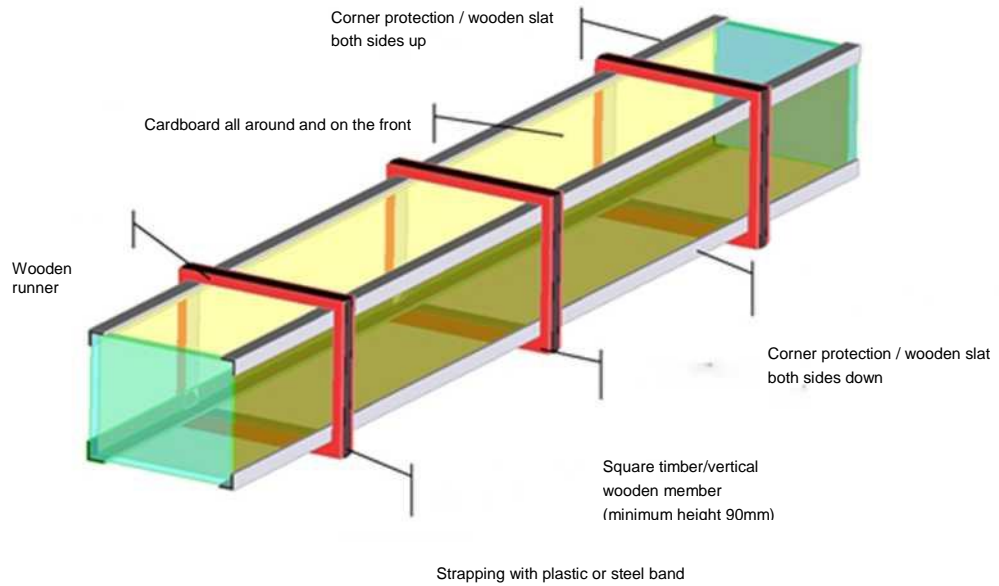

Wooden runners must never be attached in the areas marked red. Please attach the wooden runners in the areas shown in green.
(0-50; 100-165; 180-230; 250-280)

Specifications in cm

Max. length 710 cm

12. Glass deliveries

A separate glass carrying rack should be used for each glass delivery time/date.

The following provisions apply in the case of delivery on the glass carrying rack:

- Glasses must be secured with intermediate layers to avoid damage (such as self-adhesive cork pads)
- Glass panes must be strapped down tightly so that nothing slips during transportation and internal handling

Marking on both front sides with a DINA4 size label:

- GEZE identification number
- Product designation
- Number of pcs.
- Customer contract number
- Order number + position
- Delivery date
- Production order

If two or more panes of glass with different delivery times/dates are delivered on a single glass carrying rack, acceptance of the delivery will be refused.

Example label:

Sample label		
Sender Mustermann GmbH		Recipient GEZE GmbH
Order number + position 80512345 Pos. 20		
ID 12345	Designation Sample part	Number of pcs. 2
Customer contract number 51234567		Delivery date 01/06/2015
Production order 8012345		